

ANGLO-CHINESE SCHOOL
(JUNIOR)



SEMESTRAL ASSESSMENT 2 (2010)
PRIMARY 5

SCIENCE

BOOKLET A

Monday

1 November 2010

1 hour 30 minutes

Name : _____ ()

Class : P5 _____

INSTRUCTIONS TO PUPILS

DO NOT TURN OVER THE PAGES UNTIL YOU ARE TOLD TO DO SO

Follow all instructions carefully.

There are 20 questions in this booklet.

Answer **ALL** questions.

INFORMATION FOR PUPILS

The total marks for this booklet is 40.

The total time for Booklets A and B is 1 hour 30 minutes.

This question paper consists of 14 printed pages. (Inclusive of cover page)

Section A (40 marks)

For each question from 1 to 20, four options are given. One of them is the correct answer. Choose the correct option (1, 2, 3 or 4) and shade the correct oval on the Optical Answer Sheet (OAS) provided.

1 You are given the following information:

Animal X : Lays eggs; Has hair as outer covering

Animal Y : Lays eggs; Has scales as outer covering

Based on the above descriptions, which of the following is correct?

	Animal X	Animal Y
(1)	Spiny anteater	Duck-billed platypus
(2)	Duck-billed platypus	Salmon
(3)	Whales	Salmon
(4)	Spiny anteater	Dolphins

2 The diagram below shows the life cycle of Organism X.

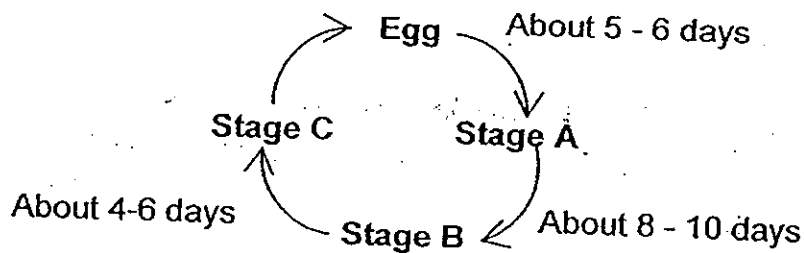

What is the least possible number of days Organism X can develop from an egg to the pupa stage?

- (1) 5
- (2) 8
- (3) 13
- (4) 15

3. A group of boys conducted the experiment below. They filled 3 similar beakers with various types of liquid of equal amount and shone a torch at them as shown below. The two items were placed in a black box. A light detecting datalogger was also placed in the black box. They recorded the results in the table below.

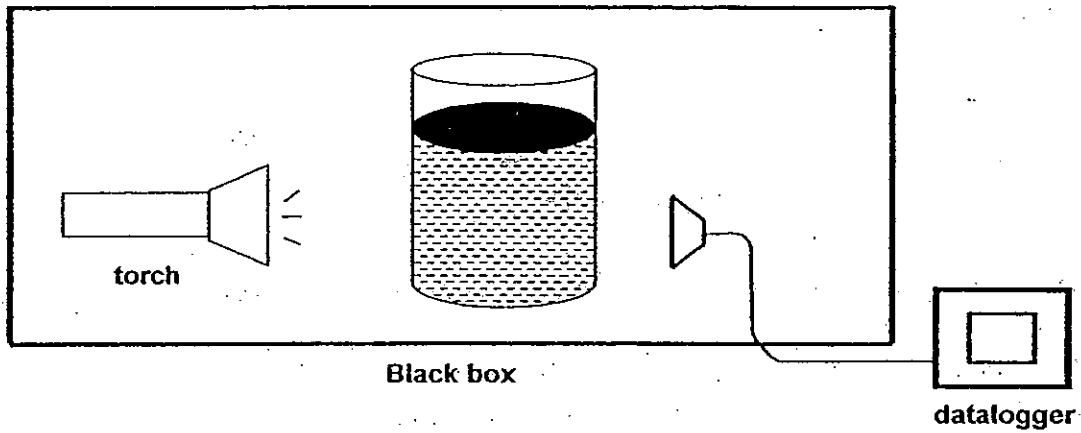

Beaker	Amount of light detected (Lux)
A	3205
B	5850
C	1500

Based on the results, which of the following best represent the 3 liquids?

	A	B	C
(1)	Mineral water	Milo	Apple juice
(2)	Apple juice	Mineral water	Oil
(3)	Oil	Apple juice	Milo
(4)	Milo	Oil	Mineral water

4. Which of the following animals produce young that do not look like them?

	List of Animals
(1)	Giraffe, Butterfly, Moth, Shark
(2)	Guppy, Crocodile, Platypus, Ant
(3)	Cockroach, Grasshopper, Duck, Horse
(4)	Mosquito, Frog, Mealworm beetle, Bee

5. The graph below compares the number of times a larva moults with the amount of food it eats.

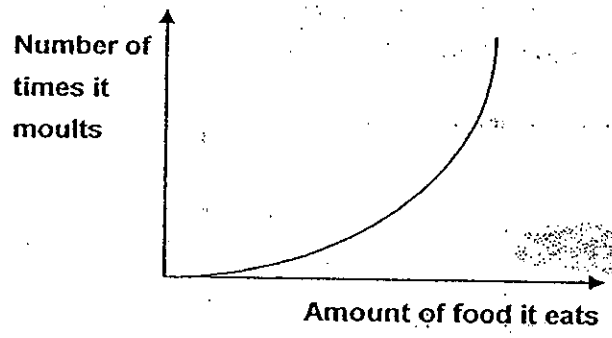

Which one of the following explains the shape of the graph?

- (1) The less the larva eats, the more often it moults.
- (2) The more the larva eats, the less often it moults.
- (3) The more the larva eats, the more often it moults.
- (4) The amount of food eaten by the larva has nothing to do with the number of times it moults.

6. Boxes A, B and C describe the 3 states of matter.

A	B	C
Definite volume No definite shape	Definite volume Definite shape	No definite volume No definite shape

The changes in water are shown below.

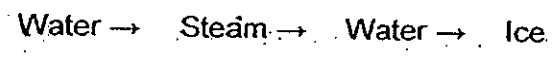

Use A, B and C to represent the above changes.

- (1) A → B → A → C
- (2) A → C → A → B
- (3) B → A → B → C
- (4) B → C → A → B

7 A plant produced the type of flower shown below.

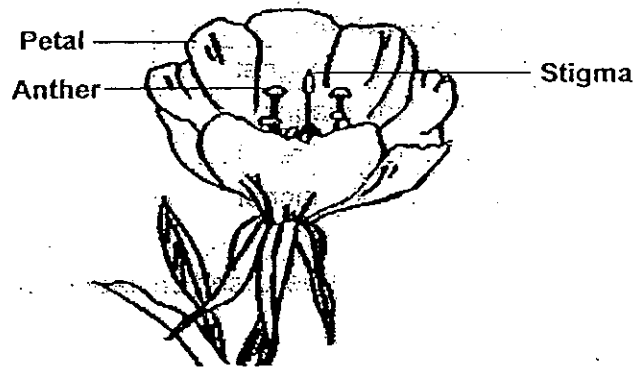

Mr Tan wanted to find out whether a fruit is produced when a certain part of the flower is removed. Below are the diagrams that show what he did to the flowers A, B and C.

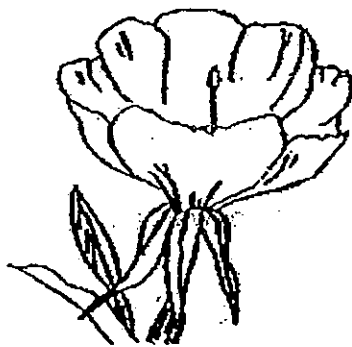

Flower A

Anthers were removed

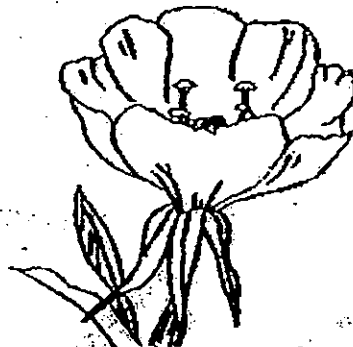

Flower B

Stigma was removed



Flower C

Petals were removed

Mr Tan then dusted pollen grains from the same type of flowers over flowers A, B and C and observed the flowers for two weeks. Which of the flowers will most likely develop into a fruit?

- (1) B only
- (2) A and C only
- (3) B and C only
- (4) A, B and C

- 8 Jack placed one end of each of the Objects P, Q, R and S to one end of a magnet. He recorded his observations as shown in the table below.

Object	Observations
P	Attracted to the magnet
Q	Repelled the magnet
R	Neither attracted nor repelled
S	Attracted to the magnet

Which of the following conclusion(s) is/are true based on Jack's observations?

- A Object Q is a magnet.
- B P and S are not magnets.
- C Object R is made of plastic.
- D Object Q and S are made of magnetic materials.

- (1) A only
- (2) A and D only
- (3) B and C only
- (4) B, C and D only

- 9 The diagram below shows a way of getting drinking water from seawater.

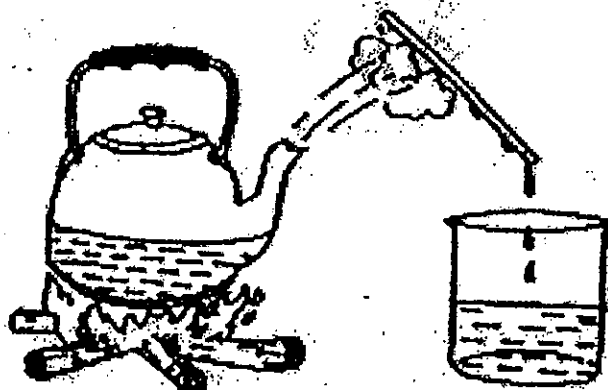

What processes occur during this method?

- A Melting
- B Freezing
- C Evaporation
- D Condensation

- (1) A and B only
- (2) A and C only
- (3) B and D only
- (4) C and D only

10

Amphibians are organisms which are very sensitive to water pollution. The graph below shows how the distance from a factory affects the number of different types of amphibians growing around the factory.

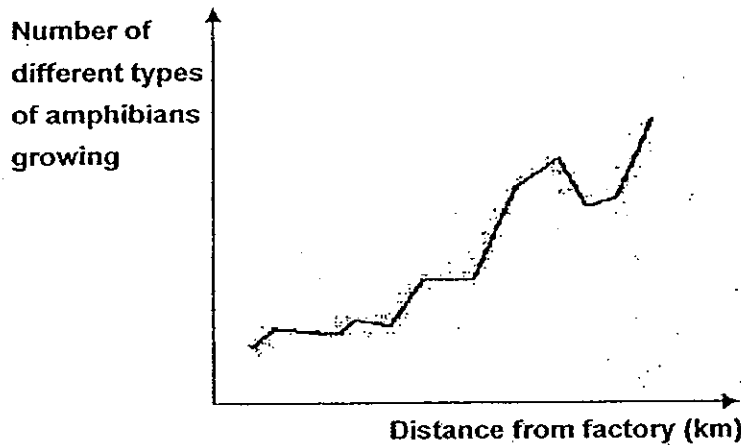

Which one of the following conclusions can be drawn from the graph above?

- (1) There are fewer types of amphibians growing near the factory.
- (2) As the distance from the factory increases, water pollution increases.
- (3) Fewer types of amphibians grow in areas further away from the factory.
- (4) The number of types of amphibians growing decreases when the distance from the factory increases.

11 The following food chain shows energy transferred from plants to animals.

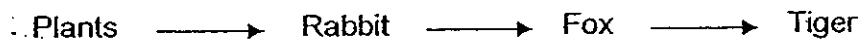

Which of the following can you deduce from the above food chain?

- A. Only the rabbit eats the plants.
 - B. The tiger gets its energy directly from the fox.
 - C. The plants, rabbit and the fox are eaten by the tiger.
 - D. Energy from the plants is transferred to the tiger through the rabbit and the fox.
- (1) B and C only
 - (2) A, C and D only
 - (3) A, B and D only
 - (4) A, B, C and D

12 The diagram below shows the human digestive system.

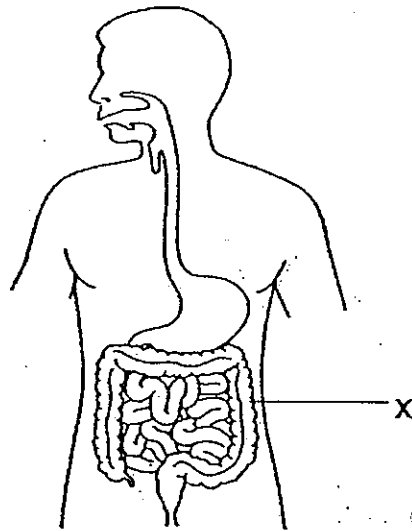

What would happen if food passes through part X too quickly?

- (1) Food will not be digested fully.
- (2) Food will not be converted to nutrients.
- (3) Digested food will not be absorbed into the bloodstream.
- (4) There will not be ~~sufficient~~ ^{sufficient} time to remove water from the undigested food.

13 The diagram below represents the blood flow in the body a few hours after having a meal.

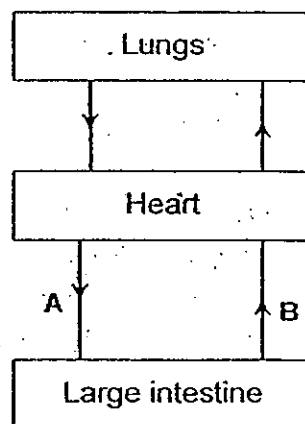

When compared with the blood in A, the blood in B has _____

- (1) less oxygen, less carbon dioxide
- (2) less oxygen, more carbon dioxide
- (3) more oxygen, less carbon dioxide
- (4) more oxygen, more carbon dioxide

- 14 Vincent wanted to find out what type of soil was suitable for growing hibiscus plants. He planted 3 hibiscus plants of similar size in three pots, X, Y and Z.

	Pot X	Pot Y	Pot Z
Material of pot	Plastic	Ceramic	Plastic
Type of soil	Garden soil	Sand	Clay
Amount of water used everyday	250 cm ³	300 cm ³	350 cm ³

The 3 plants were placed in the garden as shown below.

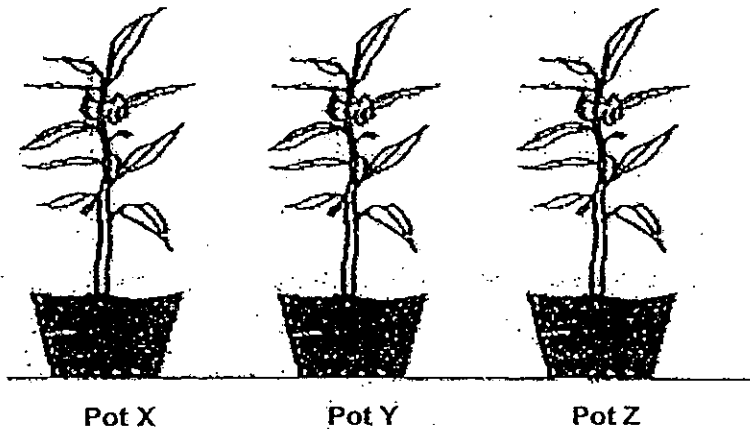

Vincent's teacher told him that he had not carried out a fair test as not all the controlled variables were kept the same. Which of the following variables should be kept the same?

- A Type of soil
 - B Type of plant
 - C Material of pot
 - D Amount of water used
- (1) A and B only
(2) B and C only
(3) B, C and D only
(4) A, B, C and D

15 Each of the farms as shown in the map below has been polluting the river. Samples of water are collected from the different parts of the river, A, B, C and D.

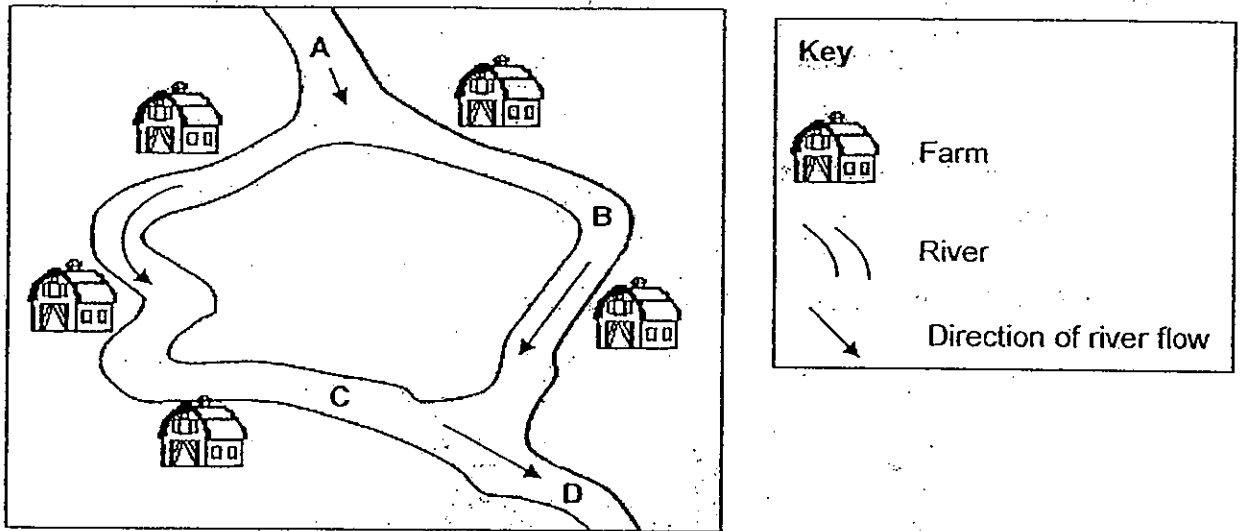

Which of the following graphs correctly reflects the number of organisms found in each part of the river?

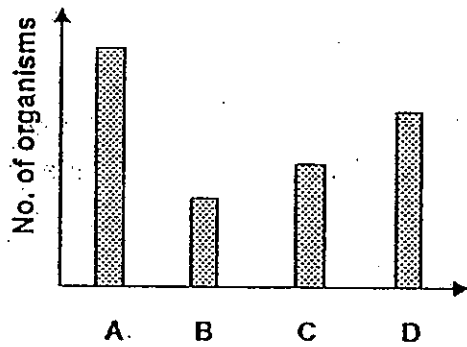

(1)

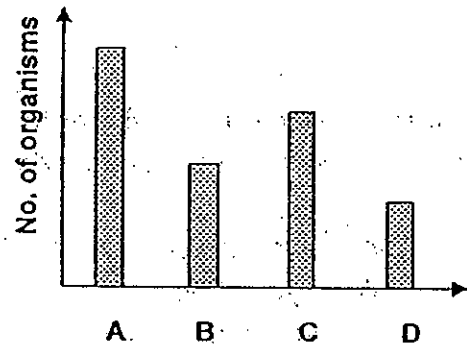

(2)

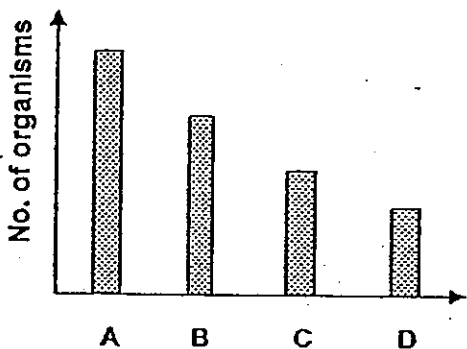

(3)

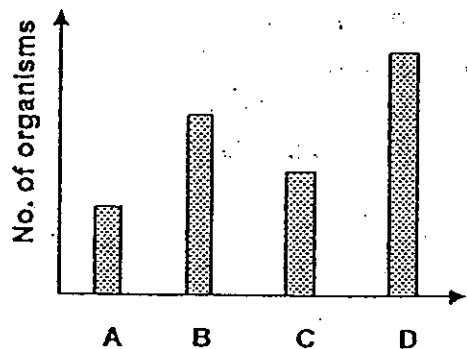

(4)

- 16 Kyle conducted an experiment in the science laboratory in which the same amount of wax was placed on the top end of three rods, A, B and C. The three rods were then placed on top of a hot surface as shown below.

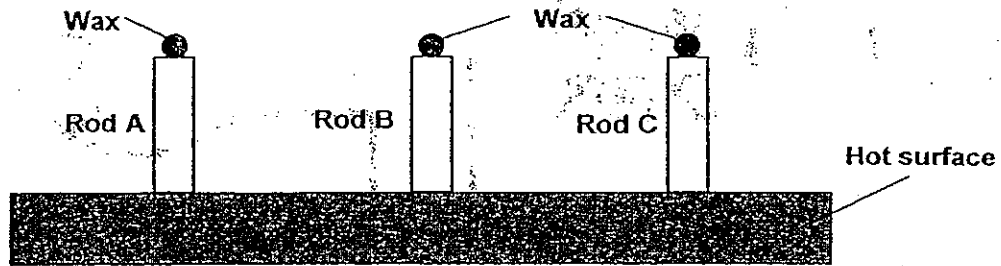

It was observed that the wax on Rod C melted first, followed by Rod A. The wax on Rod B did not melt after an hour. Based only on the experiment, what can Kyle conclude?

- A Rod B is a good conductor of heat.
- B Rod C is a good conductor of heat.
- C Rod C is a better conductor of heat compared to Rod A.
- D The wax on Rod C absorbed heat from the surroundings and therefore melted.

- (1) A and B only
- (2) B and C only
- (3) C and D only
- (4) A, B, C and D

- 17 Which of the following is **not** found in a human cheek cell but is found in a balsam plant leaf cell?

- A Nucleus
- B Cell wall
- C Cytoplasm
- D Chloroplast

- (1) A and B only
- (2) A and C only
- (3) B and D only
- (4) A, B, C and D only

18 In which of the following circuits would only 2 bulbs light up?

Circuit A

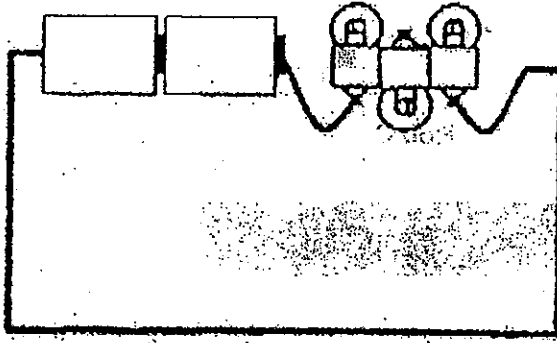

Circuit B

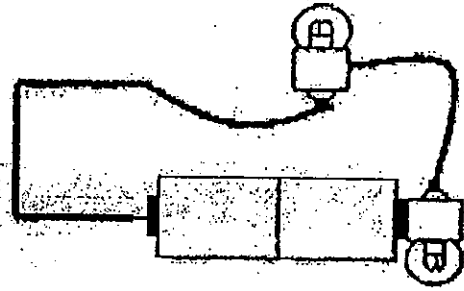

Circuit C

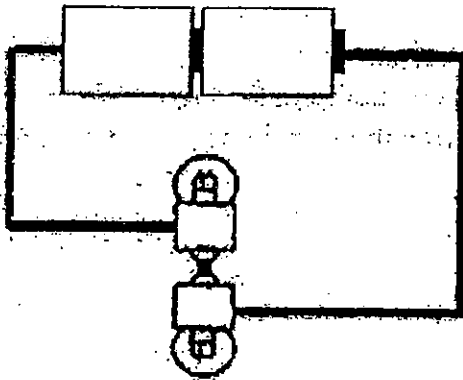

Circuit D

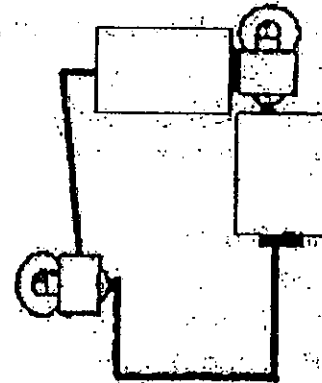

- (1) A and C only
- (2) B and D only
- (3) A, B and D only
- (4) A, C and D only

19 Study the electric circuit below.

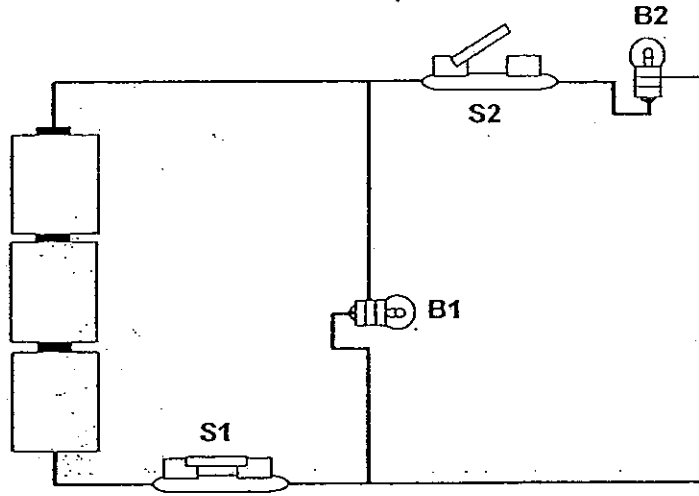

Which of the following circuit diagram represents the electric circuit given above?

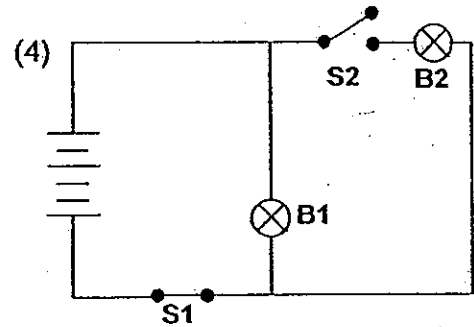
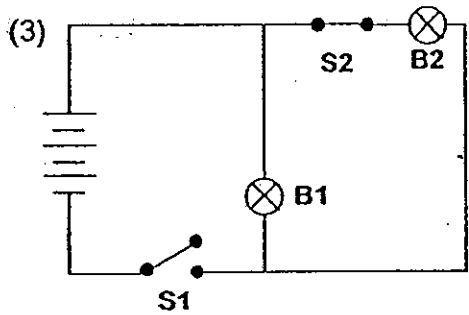
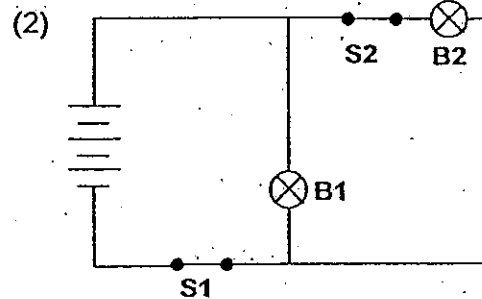
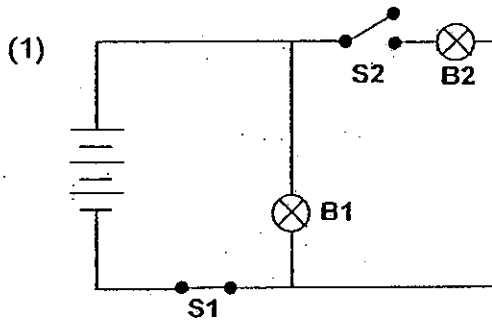

20 David let a toy car roll down the ramp as shown in the diagram below.

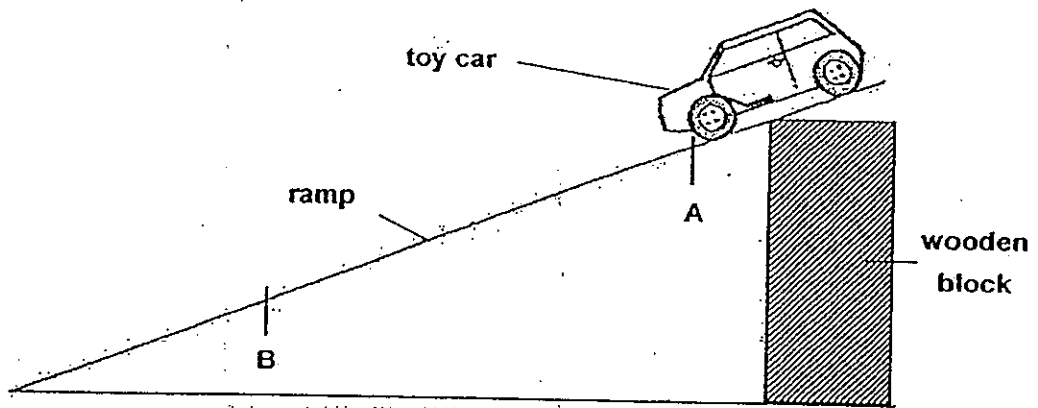

Which of the following describes the changes in potential and kinetic energy from A to B?

	Potential energy	Kinetic energy
(1)	decreases	increases
(2)	decreases	decreases
(3)	increases	increases
(4)	increases	decreases

ANGLO-CHINESE SCHOOL
(JUNIOR)



SEMESTRAL ASSESSMENT 2 (2010)
PRIMARY 5

SCIENCE

BOOKLET B

Monday

1 November 2010

1 hour 30 minutes

Name : _____ ()

Class : P5 _____

INSTRUCTIONS TO PUPILS

DO NOT TURN OVER THE PAGES UNTIL YOU ARE TOLD TO DO SO

Follow all instructions carefully.

There are 14 questions in this booklet.

Answer ALL questions.

INFORMATION FOR PUPILS

The number of marks is given in brackets [] at the end of each question or part question.

The total marks for this booklet is 40.

The total time for Booklets A and B is 1 hour 30 minutes.

This question paper consists of 12 printed pages. (Inclusive of cover page)

BOOKLET A	/ 40
BOOKLET B	/ 40
TOTAL	/ 80
Parent's signature/ Date:	

Section B (40 marks)

For questions 21 to 34, write your answers in this booklet. The number of marks available is shown in brackets [] at the end of each question or part question.

21 The diagram shows a set-up that represents the water cycle.

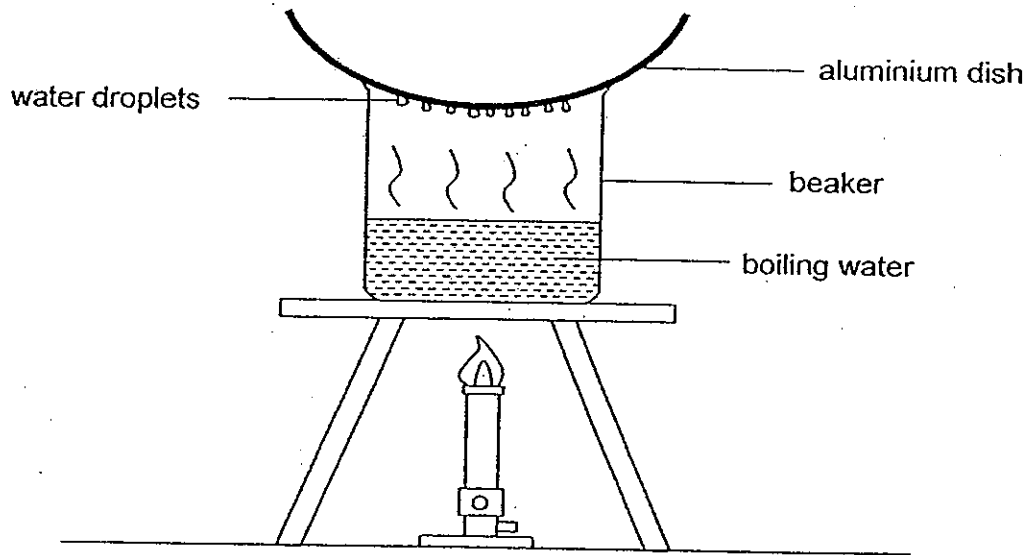

(a) What in the set-up represents clouds? [1]

(b) Does the steam gain heat, lose heat or remain the same as it touches the aluminium dish? [1]

(c) What can be done to the set-up to increase the amount of water droplets? [1]

--

Study the classification table below.

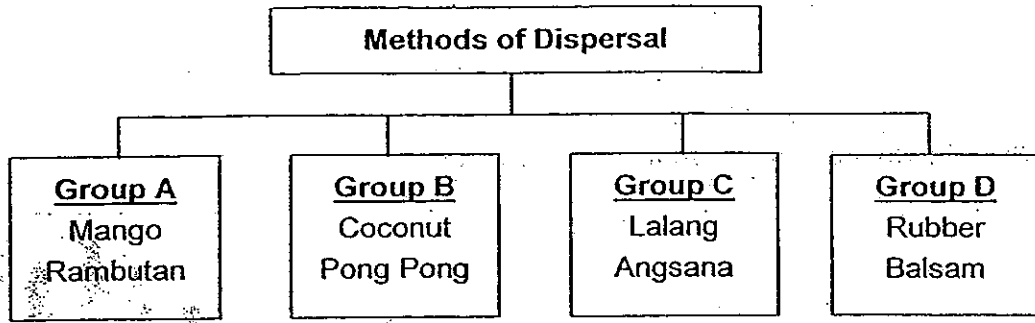

(a) Give a suitable heading for Group B.

[1]

(b) The diagram below shows the seed of an Asian Climbing Gourd.

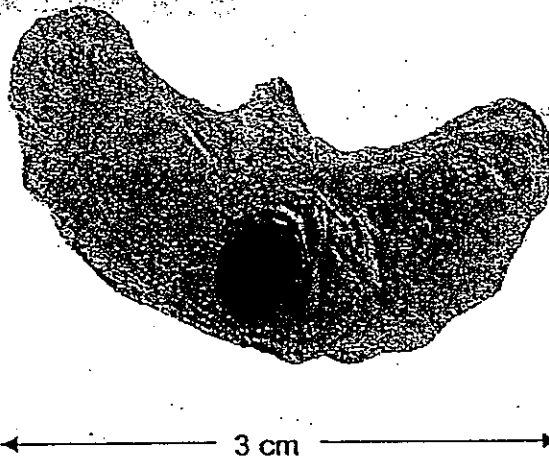

Which group (A, B, C or D) does it belong to?

[1]

(c) What characteristics help the seed of the Asian Climbing Gourd in its dispersal?

[1]

--

(a) State the purpose of the water cycle in nature?

[1]

(b) The diagram below shows an industrial town near a lake.

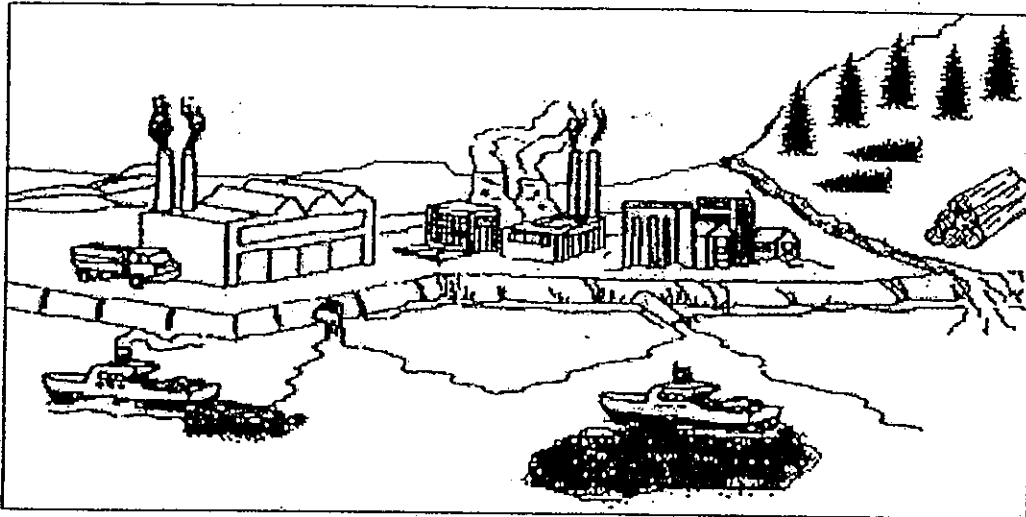

Based on the diagram, name three activities that are directly causing water pollution?

[3]

i)

ii)

iii)

24 (a) Fill in each blank with a suitable word.

[2]

The stomata and the gills are part of the _____ system

which are found in plants and fishes respectively. They are similar to the

_____ in the human body.

(b) What is the difference during the exchange of gases by the stomata and the gills?

[1]

--

(a) The diagram shows the life cycle of a flowering plant.

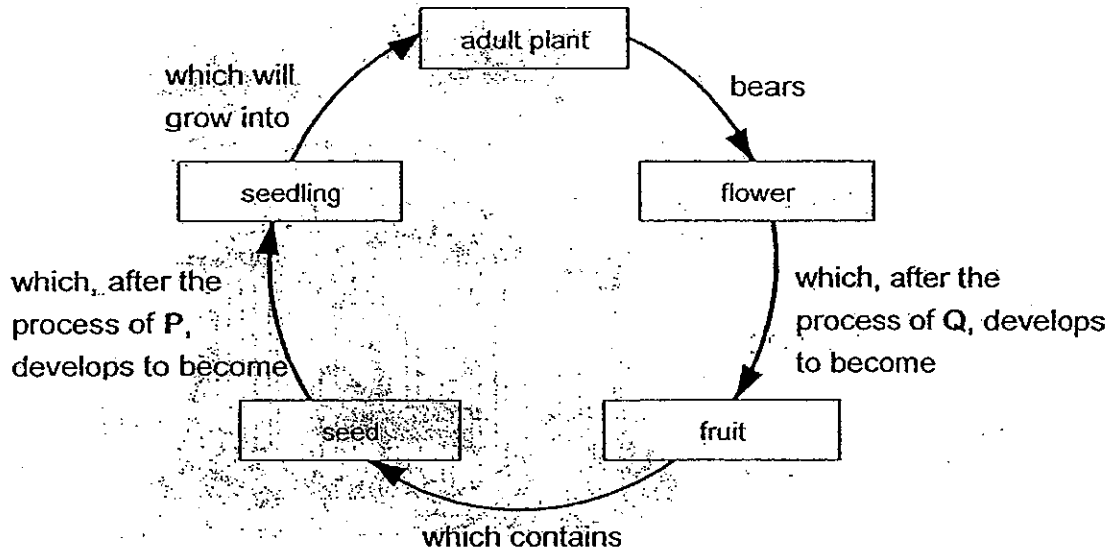

Name processes P and Q.

[2]

P: _____

Q: _____

(b) The diagram shows a flower of the hibiscus plant.

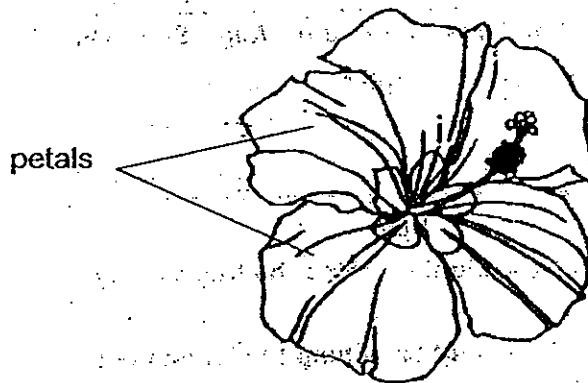

Explain why the flowers of the hibiscus plant have petals that are large and colourful?

[1]

--

Scientists divide rainforests into different layers (emergents, canopy, understory and forest floor). Each of these layers is a very different environment and supports different life forms.

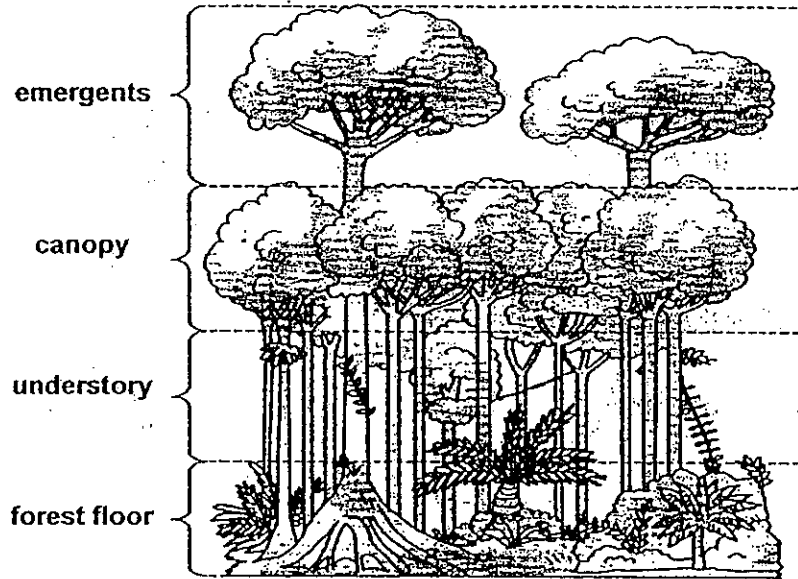

The graph below shows the amount of light reaching the tree canopy and the forest floor over a period of one year.

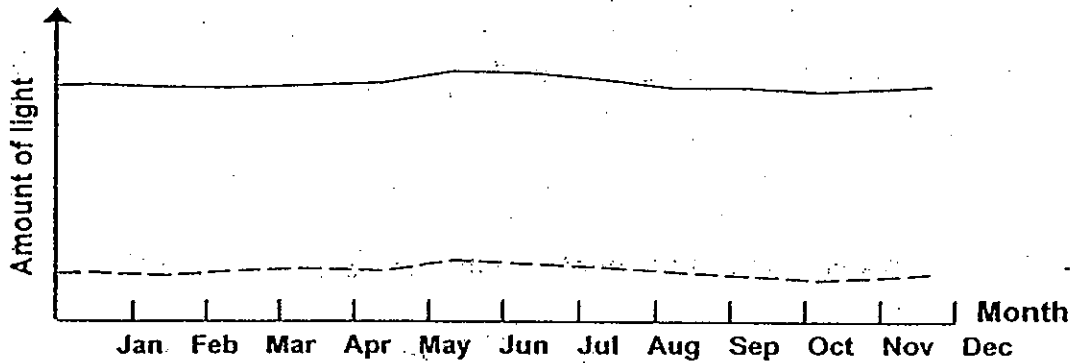

Graph 1

Key	
—————	Light reaching the tree canopy
- - - - -	Light reaching the forest floor

(a) Name the process in which the green plants in the rainforests make food. [1]

(b) List the four things that plants need to make food. [1]

--

- (c) The diagram below shows the leaf of a tree species in the rainforest when it is a young tree till it is a fully grown tree.

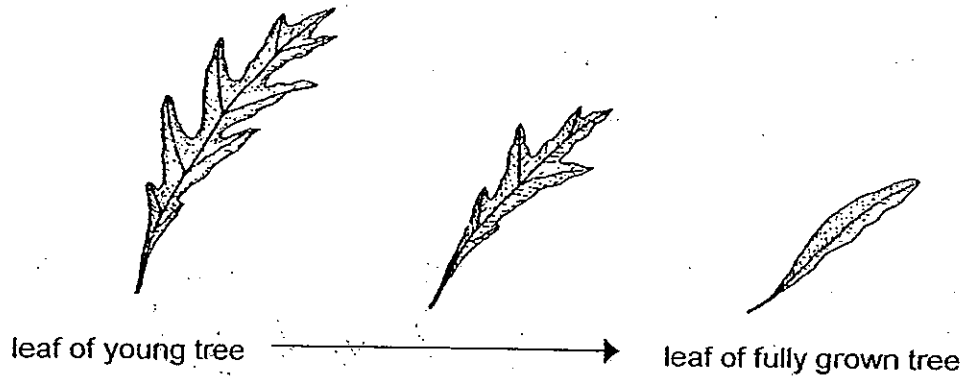

Based on the information in Graph 1, explain why the size of the leaf of the young tree is different from the fully grown tree. [2]

- 27 The diagram shows 2 flasks, X and Y, connected by a tube that has an ink droplet.

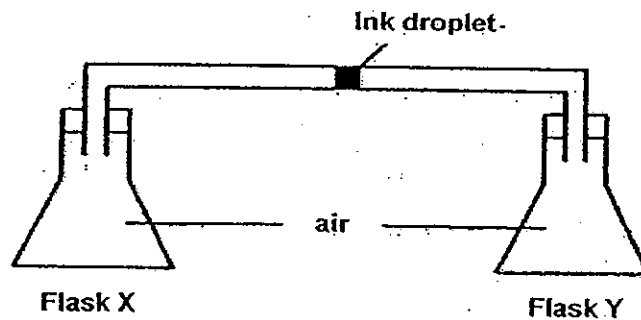

- (a) Suggest a way to move the ink droplet towards Flask Y. [1]

- (b) Explain clearly how your suggestion in (a) would cause the ink droplet to move towards Flask Y. [1]

--

28 You are given 4 light bulbs, 2 batteries, a switch and some wires.

(a) Draw a circuit diagram in the box below based on the following conditions:

- i. Only when the switch is closed, all bulbs will light up.
- ii. All bulbs are arranged in parallel.

[2]

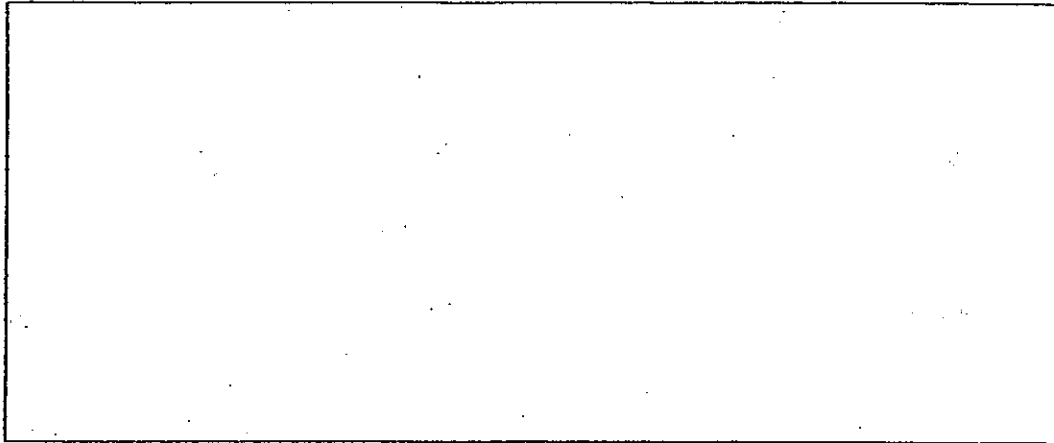

(b) Write down the energy conversion that takes place when the switch is closed.

[1]

29 The diagram shows Steven's family tree.

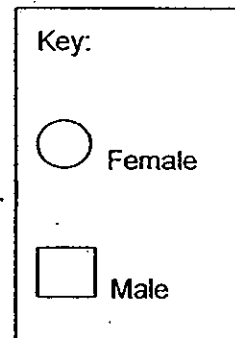
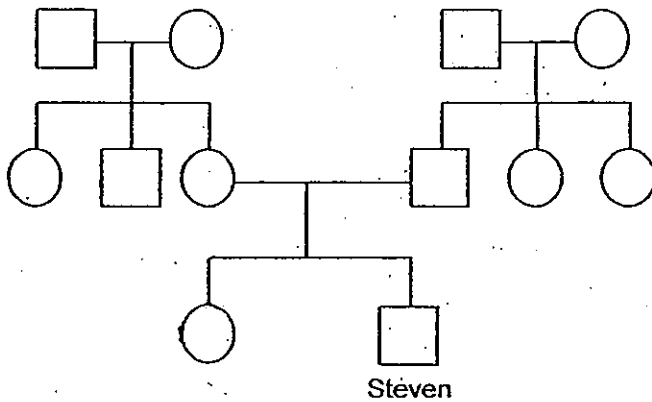

(a) How many paternal aunts does Steven have?

[1]

(b) Steven's mother recently gave birth to his baby brother. In the diagram, draw a symbol to represent the new addition to the family.

[1]

30

When we breathe, air is inhaled and exhaled. The table below shows two differences between inhaled air and exhaled air. Complete the table below by giving two other differences. [2]

Differences between		
	Exhaled air	Inhaled air
1	Contains less oxygen	Contains more oxygen
2	Contains more carbon dioxide	Contains less carbon dioxide
3		
4		

31

Jonathan had three rods, X, Y and Z of unknown material. He placed them at various positions A, B and C of the circuit shown below.

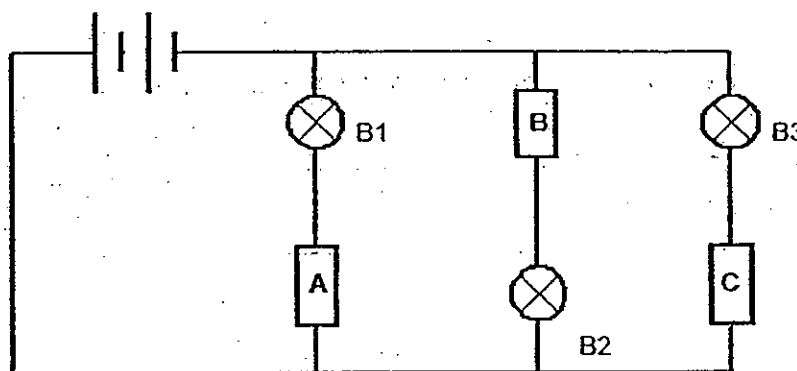

Rods X and Y are electrical insulators while Rod Z is an electrical conductor. In the table below, tick (✓) the bulbs that will light up based on the positions of the Rods X, Y and Z. [3]

Positions where the rods were placed			Would the light bulbs light up?		
A	B	C	B1	B2	B3
X	Y	Z			
Y	Z	X			
Z	X	Y			

--

- 32 Jeffrey conducted an experiment to find out if the magnetic strength of a bar magnet increases with its size. He hung four magnets at the same distance away from similar plastic trays with equal number of paper clips.

The result of his experiment is shown below.

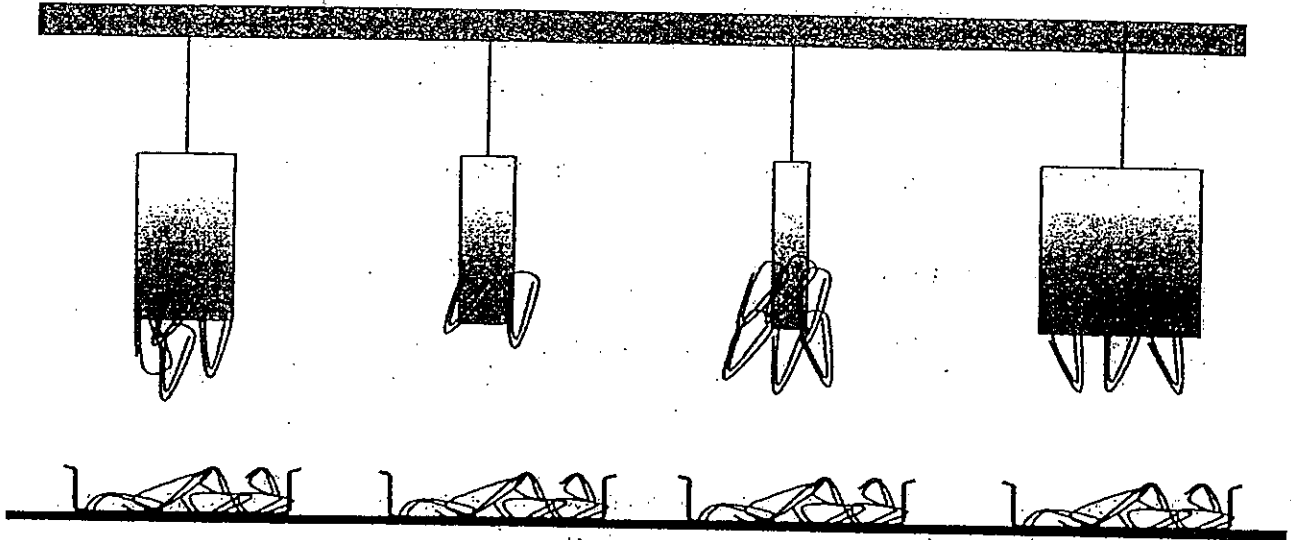

- (a) What conclusion can Jeffrey draw based on his result?

[1]

- (b) Based on Jeffrey's experiment, which of the following statements are true?
(Indicate the true statements with a letter "T" in the boxes provided) [1]

i) Magnetic force can act at a distance.

ii) The paper clips are made of magnetic materials.

iii) The trays are made of non-magnetic materials.

iv) Magnetism can pass through non-magnetic materials.

Lina wanted to find out how the different thickness of material X can affect the amount of light passing through it. She conducted an experiment in a dark room as shown below.

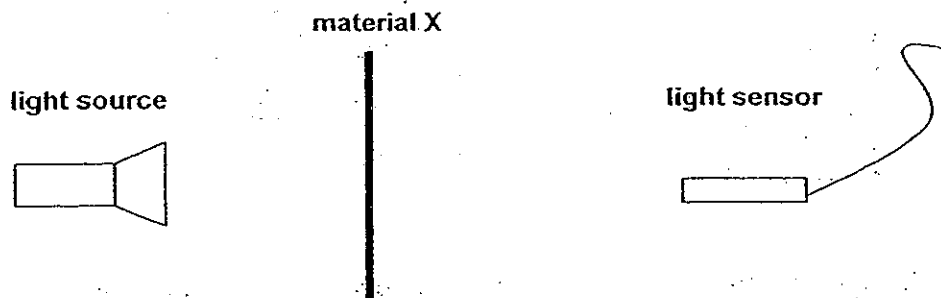

The amount of light passing through material X was captured by a light sensor. She used material X of different thickness and recorded the amount of light passing through it in the table below.

Thickness of material X (mm)	Amount of light captured (units)
1	500
10	310
15	250
25	105
30	20

(a) State a property of material X. [1]

(b) State the relationship between the thickness of material X and the amount of light passing through it. [1]

(c) Explain why the experiment needs to be conducted in a dark room? [1]

34 Study the circuit tester and circuit card below.

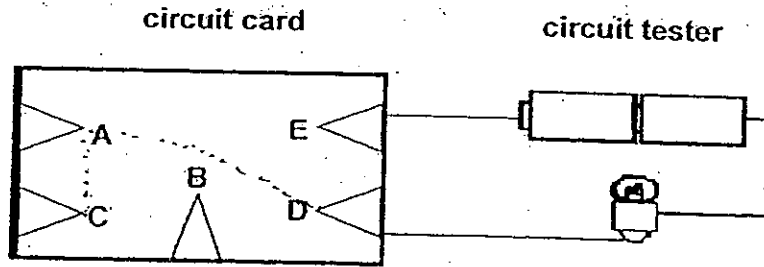

A, B, C, D and E are 5 contact points on the circuit card (made with cardboard). The wires underneath the circuit card are not shown. When the ends of the 2 wires of the circuit tester are connected to contact points, the bulb is either lit or unlit.

The table below shows the results obtained when different pairs of contact points were connected to the circuit tester.

Points connected to circuit tester	Observation
D and E	bulb unlit
C and A	bulb lit
B and E	bulb unlit
A and D	bulb lit
A and B	bulb unlit

- (a) In the diagram below, draw **only 2 lines** to represent the wires that connect the contact points for the above observations. [1]

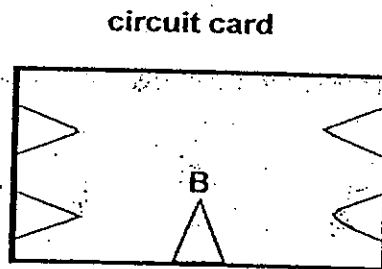

- (b) What would happen if the circuit card is made of metal? Explain why. [2]

Ans

EXAM PAPER 2010

SCHOOL : ACS PRIMARY
SUBJECT : PRIMARY 5 SCIENCE

TERM : SA2

Q1	Q2	Q3	Q4	Q5	Q6	Q7	Q8	Q9	Q10	Q11	Q12	Q13	Q14	Q15	Q16	Q17
2	3	2	4	3	2	2	2	4	1	3	4	2	3	3	2	3

Q18	Q19	Q20
4	1	1

ANGLO-CHINESE SCHOOL (JUNIOR)
P5 SA2 SCIENCE 2010

SECTION B

Qn	Model Answer
21a	Tiny <u>water droplets</u> [1]
21b	Lose heat [1]
21c	Add ice on top of the aluminum dish [1]
22a	Dispersal by <u>water</u> . [1]
22b	Group C [1]
22c	It is small / flat and <u>has wing-like structure</u> . [1]
23a	Ensure never-ending supply of water on Earth [1]
23b	Dumping of waste [1] Factories giving out harmful gases [1] Oil Spill [1] Deforestation [1]
24a	Respiration / Lungs / Air sacs [1]
24b	Stomata take in carbon dioxide and give out oxygen while gills take in oxygen and gives out carbon dioxide [1]
25a	P: germination [1] Q: <u>pollination</u> [1] - <i>Fertilisation</i>
25b	To attract <u>insects</u> for <u>pollination</u> .
26a	Photosynthesis [1]
26b	<u>Sunlight (light), water, carbon dioxide, chlorophyll</u> . [1]
26c	The leaf canopy of the trees is thick and tight so <u>little light gets filtered through</u> , thus the young leaf needs a <u>bigger surface area to get / obtain sunlight</u> . [2]
27a	Use a bunsen burner and heat up flask X. / Place flask Y in a container of ice. [1]
27b	When you heat up Flask X, the air in it will get <u>heated and expand</u> . The <u>expanded air goes up the tube and pushes the ink</u> . [2]

ANGLO-CHINESE SCHOOL (JUNIOR)
P5 SA2 SCIENCE 2010

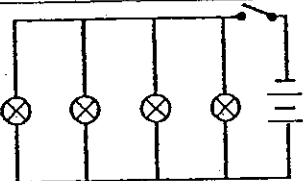
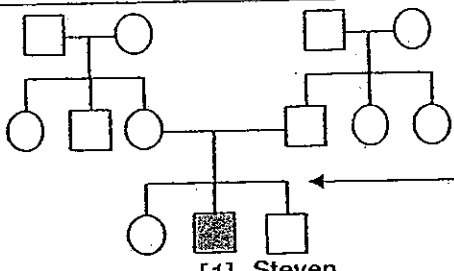
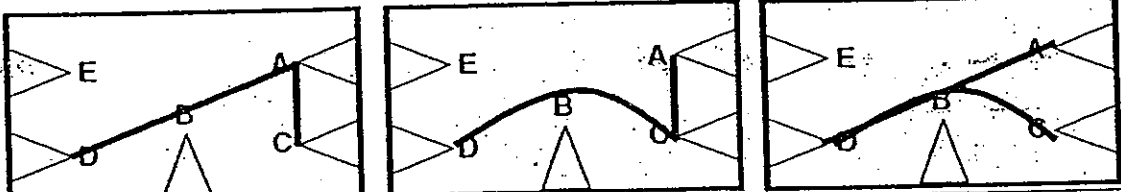
28a	 <p>[2]</p>																
28b	Chemical energy → Electrical Energy → light energy + heat energy [1]																
29a	2 [1]																
29b	 <p>(Anywhere along this line)</p> <p>[1] Steven</p>																
30	<table border="1" style="width: 100%; border-collapse: collapse;"> <thead> <tr> <th style="width: 50%; background-color: #cccccc;">Exhaled air</th> <th style="width: 50%; background-color: #cccccc;">Inhaled air</th> <th></th> </tr> </thead> <tbody> <tr> <td>Warmer / hotter</td> <td>Cooler / colder</td> <td>[1]</td> </tr> <tr> <td>More water vapour</td> <td>Less water vapour</td> <td>[1]</td> </tr> </tbody> </table>	Exhaled air	Inhaled air		Warmer / hotter	Cooler / colder	[1]	More water vapour	Less water vapour	[1]							
Exhaled air	Inhaled air																
Warmer / hotter	Cooler / colder	[1]															
More water vapour	Less water vapour	[1]															
31	<table border="1" style="width: 100%; border-collapse: collapse;"> <thead> <tr> <th style="width: 33%; background-color: #cccccc;">B1</th> <th style="width: 33%; background-color: #cccccc;">B2</th> <th style="width: 33%; background-color: #cccccc;">B3</th> <th></th> </tr> </thead> <tbody> <tr> <td></td> <td></td> <td style="text-align: center;">✓</td> <td>[1]</td> </tr> <tr> <td></td> <td style="text-align: center;">✓</td> <td></td> <td>[1]</td> </tr> <tr> <td style="text-align: center;">✓</td> <td></td> <td></td> <td>[1]</td> </tr> </tbody> </table>	B1	B2	B3				✓	[1]		✓		[1]	✓			[1]
B1	B2	B3															
		✓	[1]														
	✓		[1]														
✓			[1]														
32a	Size of the magnet does not affect the magnetic strength of the magnet. [1]																
32b	<table style="border: none;"> <tr> <td style="border: none;">i) T</td> <td rowspan="4" style="border: none; vertical-align: middle;">} 2 correct - [½]</td> </tr> <tr> <td style="border: none;">ii) T</td> </tr> <tr> <td style="border: none;">iii) T/-</td> </tr> <tr> <td style="border: none;">iv) -</td> </tr> </table>	i) T	} 2 correct - [½]	ii) T	iii) T/-	iv) -											
i) T	} 2 correct - [½]																
ii) T																	
iii) T/-																	
iv) -																	
33a	Translucent [1]																
33b	As the thickness of material X increases, the amount of light passing through it decreases. [1]																
33c	The experiment will not be accurate if <u>other light sources</u> are captured by the light sensor. [1]																
34a	 <p>[1]</p>																
34b	Metal is a good conductor of electricity. Thus the bulb will light up wherever the circuit tester touches the circuit card. [2]																

